

DANCOVER[®]

.com

Manual for
Storage tent
4m Series PVC

DANCOVER[®]

.com

Safety Advice

Attention

In some countries approval is needed to set up a marquee/tent larger than 75 m². It is your responsibility to comply with local rules and regulations and to ensure that the marquee/tent is assembled correctly.

In case of bad weather conditions, it is your responsibility to ensure the marquee/tent is safely secured and that the marquee/tent does not cause damage to others.

Do not use open fire, welding equipment or other sources which can ignite, inside or close to the tent.

The marquee/tent must be safely secured. We recommend you secure your marquee/tent with straps and pegs as soon as it is assembled.

Make sure to check if the marquee/tent is covered by your home contents insurance.











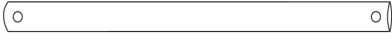

Marquees/tents must be evacuated under extreme weather conditions.

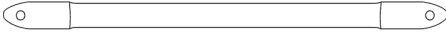
In the event of snow always remove snow from the roof of the marquee/tent regularly to prevent snow from building on the roof as heavy snow can cause the marquee/tent to collapse.







In the event of rain there is a risk of rain puddles building up on top of the roof of the marquee/tent. Heavy rain puddles can cause the roof to collapse. It is your responsibility to ensure rain puddles do not build up. As a precaution, make sure the roof of the marquee/tent is stretched out properly and adequately over the side frames of the marquee/tent and remove rain water regularly.

Please always check our website for the latest safety advice and manual.



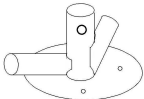
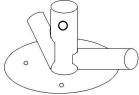
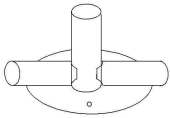
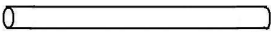
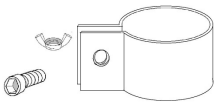
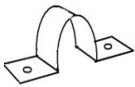

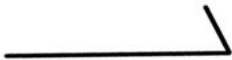
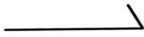
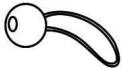



4m storagetent manual

Part no.			4x4m	4x6m	4x8m	4x10m
1	Middle Leg 1880mm 50-50		2	4	6	8
2	Frame pole 1880mm 38-38		6	11	16	21
3-1	Frame pole 1880mm 38-38		2	2	2	2
3-2	Frame pole 1880mm 38-38		2	2	2	2
4	Frame pole 2030mm 50-50		6	8	10	12
5	Groundbar pipe		4	4	4	4
6	Diagonal support 1174mm 25-25		4	4	4	4
7	Roof support 1652mm 25-25		3	4	5	6
8	Corner Leg 1880mm 50-50		4	4	4	4
9	Male doorbar		2	2	2	2
10	Female doorbar		2	2	2	2
11	Pillar		4	4	4	4
12	Pillar		4	4	4	4
13	Celling rail		2	2	2	2

4m storagetent manual

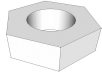
Part no.			4x4m	4x6m	4x8m	4x10m
14	Ceiling rail		2	2	2	2
15-1	3-way Connector 54-42 (A)		6	6	6	6
15-2	4-way Connector 54-42 (B)		3	6	9	12
16	3-way Connector for corner		2	2	2	2
17	3-way Connector for corner		2	2	2	2
18	3-way Connector for sidewall		6	8	10	12
23	Strengthen bar		4	6	8	10
24	Bracket		10	12	14	16
25	Groundbracket		4	6	8	10
26	Peg 400mm		8	12	16	20
27	Spiral peg		4	4	4	4
28	Long peg		10	12	14	16
29	Small peg		28	32	36	40
30	Bungeeball long		44	44	44	44
31	Rope		4	4	4	4

4m storagetent manual

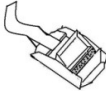
Part no.			4x4m	4x6m	4x8m	4x10m
32	Screw M6X30		8	10	12	14
33	Screw M6X45		5	5	5	5
35	M6 Wingnut		13	15	17	19
37	Screw M8x50mm		40	50	60	70
38	Screw M8X60mm		38	46	54	62
39	M8 Nut		78	96	114	132
40	Spanner		1	1	1	1
41	Steel tension bar		8	12	16	20
42	Turnbuckle		4	6	8	10
43	Tit down		4	4	4	4
44	Steel clip		16	20	24	28
45	Roof		1	1	1	1
46	Endwall		2	2	2	2

I

Select a flat ground for the tent, unpack the carton and check all the parts including tubes, tent and accessories... etc. are present and the same as the list.

Assemble the framework of rooftop by joining the portion (15-1.15-2) together with poles (2.3-1.3-2.4) NO.3 is on four corners for diagonal pipe

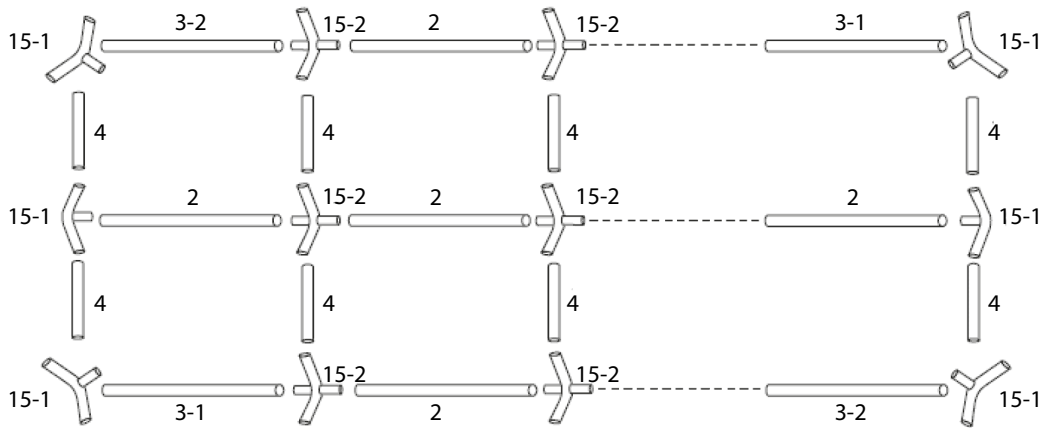

II

To ensure the screw fixed to every pole tightly. And then use the turnbuckle and steel tension bar to tighten the top structure.

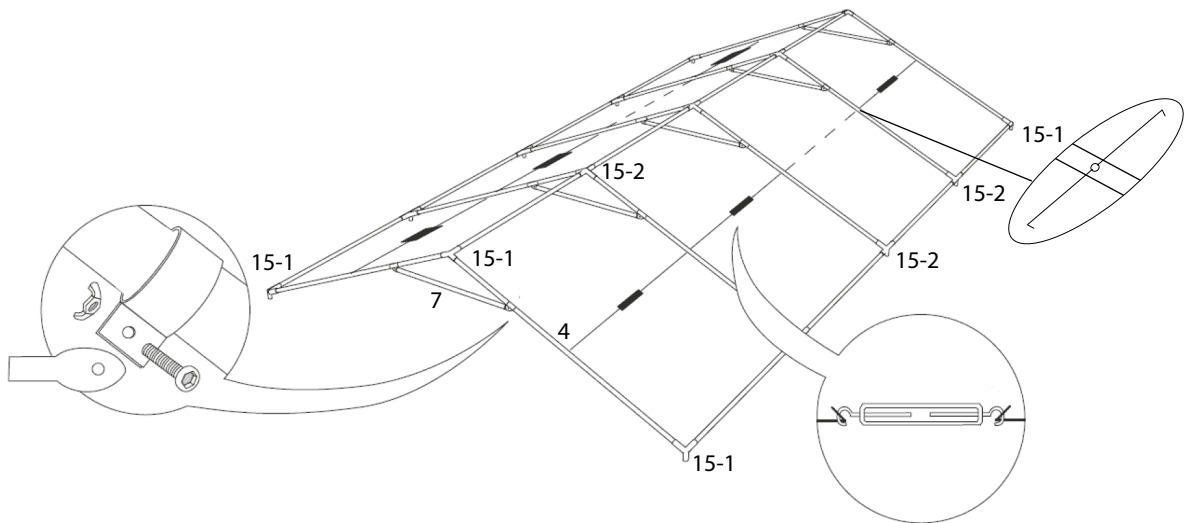

III

Attach one end of supported pole (1.8) to the joints

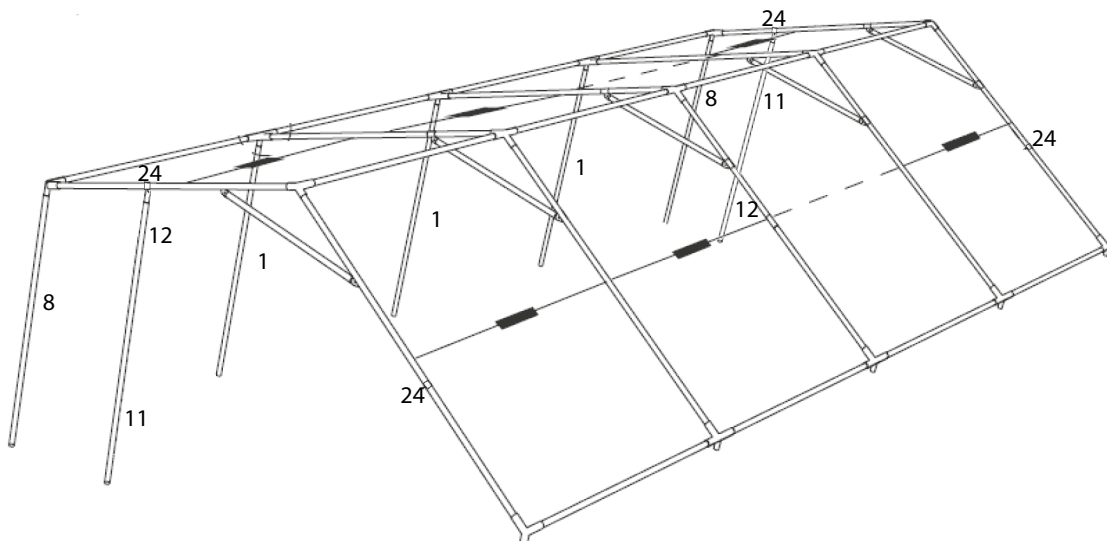

IV

Attach the another supported poles (1.8) to the joints, built-up the framework.

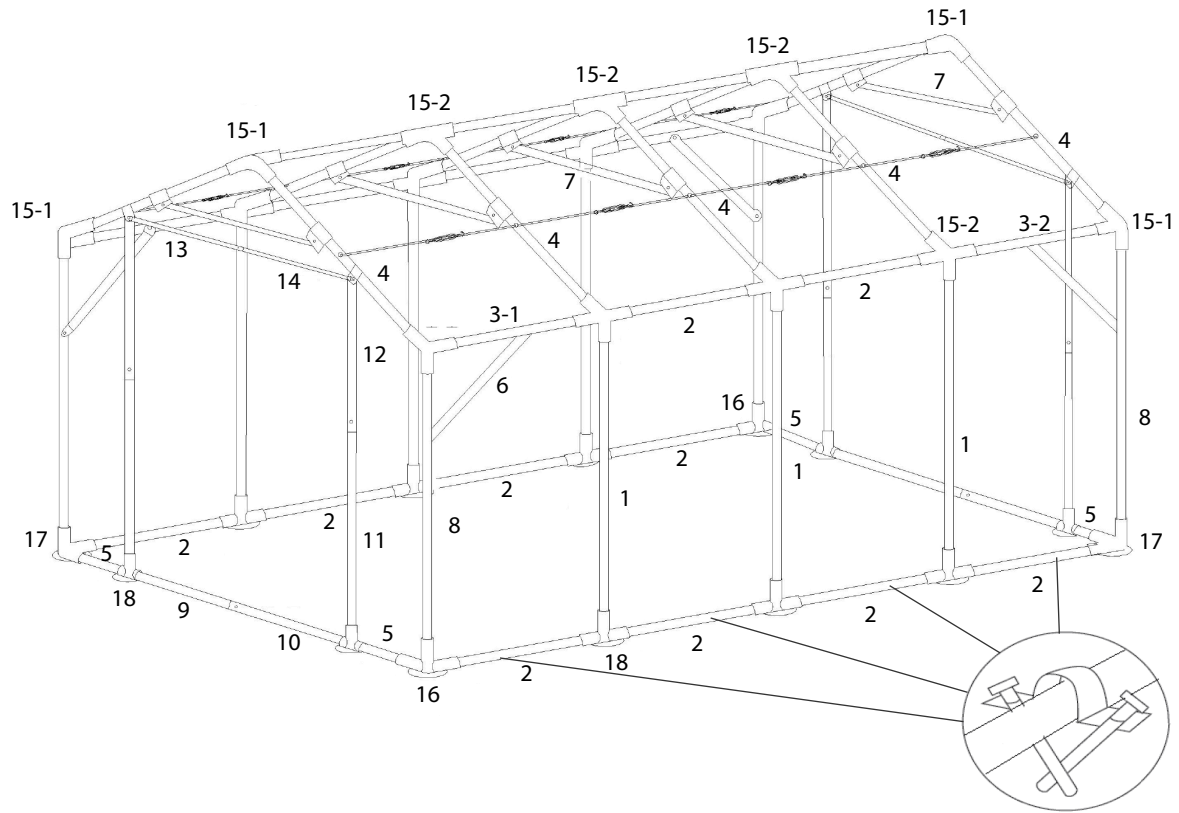

V

You facilitate the assembly and dismantling by pulling the roof with ropes on tent frame. Use the steel clips to fasten the cover to the frame. Each section we offer bracket and nail to fasten the frame to ground.

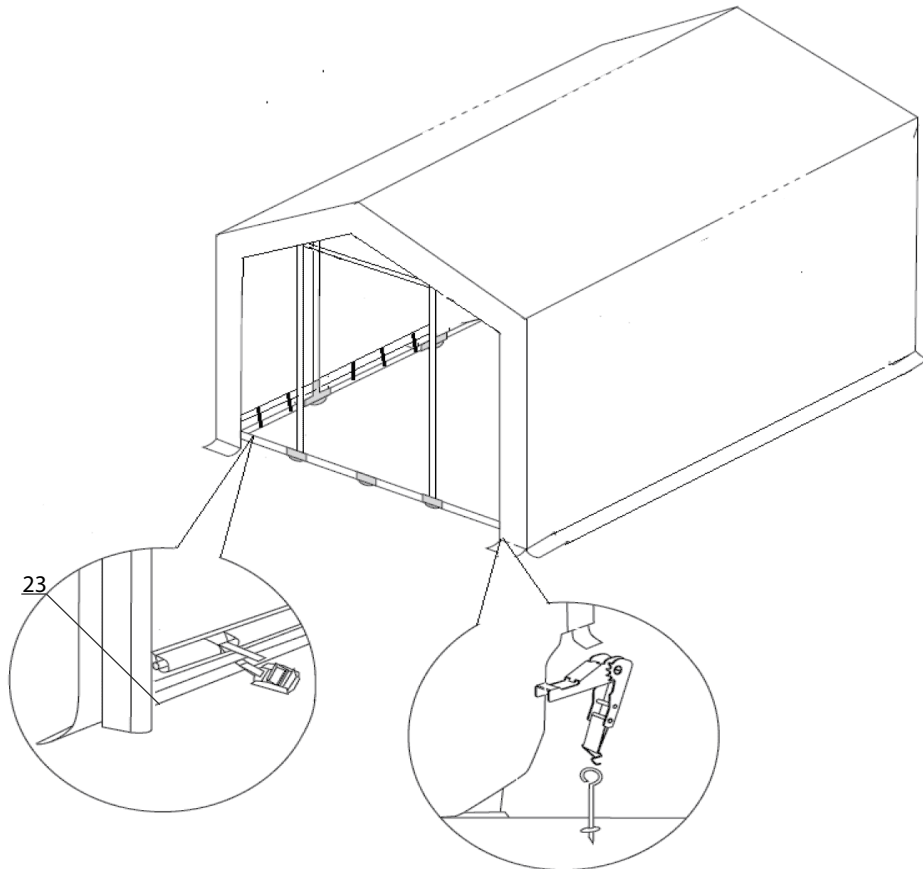

VI

Spread the wall panel and door panel attach to framework by using the bungee cords clasping the frame to grommets that is construct over the wall panel and door panel to ensure stability. Also use the short pegs to fix the doors to the ground.

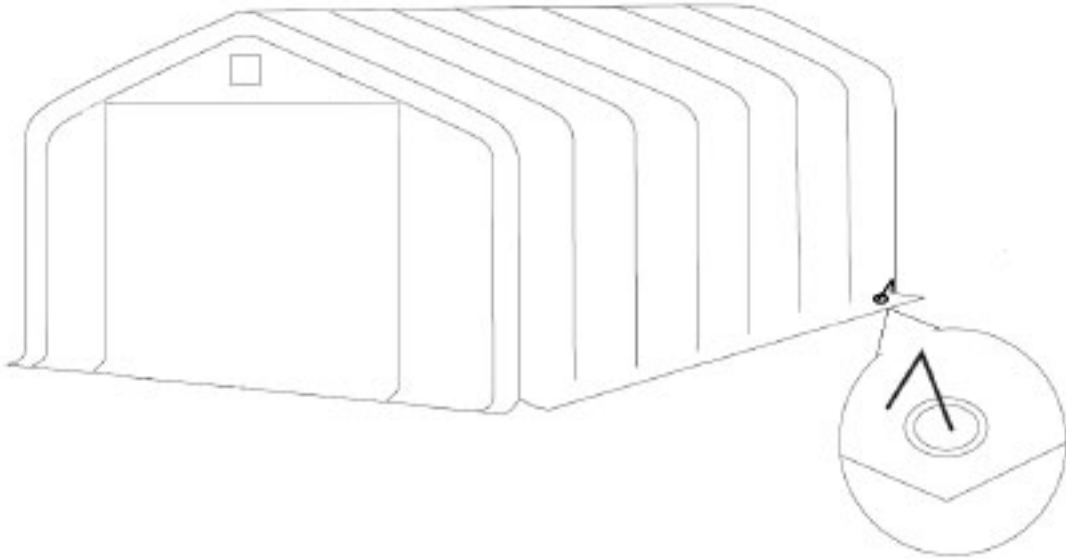

Warning

1. In order to avoid being rusted by air, oil is covered on the surface of the pipes, before set up the tent, please remove the oil carefully first to keep the cover clean.
2. Take note that the tent needs to be handled carefully to avoid damage.
3. Do not force the frame as they may be damaged in the process.
4. Tents are meant as temporary shelter and must be evacuated under extreme weather conditions.

Please select a suitable site for the tent to avoid the damage to underground sprinkler systems, water, gas or electrical lines.

Contact information

Head office:

Dancover A/S
Nordre Strandvej 119 G
3150 Hellebæk
Denmark

For more information
please visit:
www.dancovershop.com

National contact

Denmark:

denmark@dancover.com

UK:

uk@dancover.com

Germany:

germany@dancover.com

France:

france@dancover.com

Sweden:

sverige@dancover.com

Finland:

suomi@dancover.com

Poland:

polska@dancover.com

Luxembourg:

luxembourg@dancover.com

Spain:

espana@dancover.com

Italy:

italia@dancover.com

Switzerland:

schweiz@dancover.com

Austria:

austria@dancover.com

Norway:

norge@dancover.com

Nederland:

nederland@dancover.com

Ireland:

ireland@dancover.com

Belgium:

belgique@dancover.com